

*End display / half-island, free standing.  
Consisting of:*

*Upright, foot, footcover, kickplate, base shelf with or without label moulding, bottom tie bar, galvanized crossbar, top cap, masonite or metal backing, joiner (joiner for masonite backing only).*

**Available in the following heights:**

*36", 48", 54", 60", 66", 72", 84", 90" et 96"*

**In the following widths:**

*24", 30", 36" et 48"*

**And in the following depths (base shelf):**

*8", 10", 12", 14", 16", 18", 20", 22", 24", 26", 28", 30" and without base.*

**PRODUCT INDEX**

<i>Attachment for promotional wire mesh side panel</i>	D-16
<i>End display (Half Island)</i>	D-0 to D-10
<i>Endframe</i>	D-11
<i>Endframe kickplate</i>	D-11, 12
<i>Endframe upper extension</i>	D-11
<i>Enframe base shelf with kickplates</i>	D-12
<i>Heavy duty promotional base</i>	D-12
<i>Heavy-duty base for endframe</i>	D-12
<i>Lower attachment for promotional side panel</i>	D-15, 16
<i>Promotional base with kickplates</i>	D-12
<i>Promotional perforated masonite side panel</i>	D-13 to D-16
<i>Promotional wire mesh side panel</i>	D-16
<i>Promotional wire mesh side panel wire basket</i>	D-16
<i>Z-shaped attachment</i>	D-16

**ENDFRAME WITH PERFORATED MASONITE BACKING**

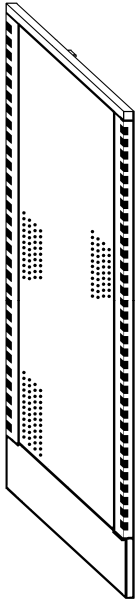

CBI-00-3041 24" x 41"(48") high  
 CBI-00-2447 24" x 47"(54") high  
 CBI-00-2453 24" x 53"(60") high  
 CBI-00-3059 24" x 59"(66") high  
 CBI-00-3065 24" x 65"(72") high  
 CBI-00-3071 24" x 71"(78") high

CBI-00-3041 30" x 41"(48") high  
 CBI-00-3047 30" x 47"(54") high  
 CBI-00-3053 30" x 53"(60") high  
 CBI-00-3059 30" x 59"(66") high  
 CBI-00-3065 30" x 65"(72") high  
 CBI-00-3071 30" x 71"(78") high

CBI-00-3641 36" x 41"(48") high  
 CBI-00-3647 36" x 47"(54") high  
 CBI-00-3653 36" x 53"(60") high  
 CBI-00-3659 36" x 59"(66") high  
 CBI-00-3665 36" x 65"(72") high  
 CBI-00-3671 36" x 71"(78") high

**UPPER EXTENSION FOR ENDFRAME**

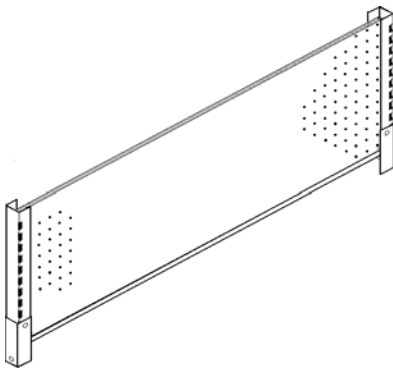

EBI-00-2406 6" x 24"  
 EBI-00-2412 12" x 24"  
 EBI-00-2418 18" x 24"

EBI-00-3006 6" x 30"  
 EBI-00-3012 12" x 30"  
 EBI-00-3018 18" x 30"

EBI-00-3606 6" x 36"  
 EBI-00-3612 12" x 36"  
 EBI-00-3618 18" x 36"

*Perforated masonite backing included.*

**ENDFRAME KICKPLATE**

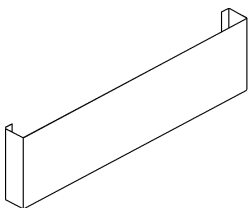

004-06-0030 9" high x 30" wide

004-06-0036 9" high x 36" wide

*Can also be used as a bottom extension.*

**ENDFRAME KICKPLATE**

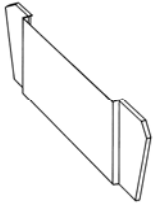

- PPC-00-3014 *for 30" wide frame, island with base 14"/14"*
- PPC-00-3016 *for 30" wide frame, island with base 16"/16"*
- PPC-00-3018 *for 30" wide frame, island with base 18"/18"*
  
- PPC-00-3618 *for 36" wide frame, island with base 18"/18"*

**END DISPLAY BASE SHELF WITH KICKPLATE**

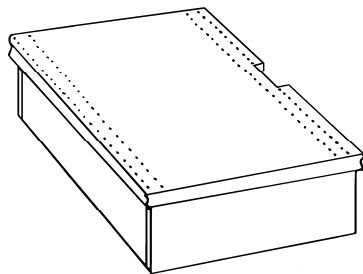

- TBI-01-3214 *14" x 32" (island with base 14"/14")*
- TBI-01-3218 *18" x 32" (island with base 14"/14")*
  
- TBI-01-3614 *14" x 36" (island with base 16"/16")*
- TBI-01-3618 *18" x 36" (island with base 16"/16")*
- TBI-01-3624 *24" x 36" (island with base 16"/16")*
  
- TBI-01-4018 *18" x 40" (island with base 18"/18")*

**HEAVY-DUTY BASE FOR END DISPLAY**

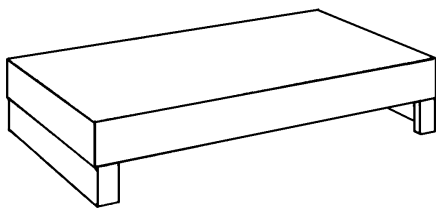

- 013-02-3624 *24" x 36"*
- 013-02-4824 *24" x 48"*
- 013-02-5424 *24" x 54"*
  
- 013-02-6024 *24" x 60"*
- 013-02-6624 *24" x 66"*
- 013-02-7224 *24" x 72"*

**PROMOTIONAL BASE WITH KICKPLATE**

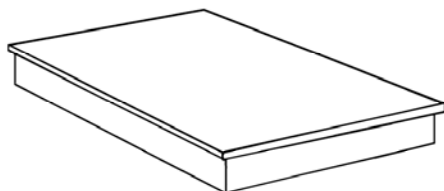

- PRO-04-3020 *20" x 30"*
- PRO-04-3030 *30" x 30"*
  
- PRO-04-3624 *24" x 36"*
- PRO-04-3636 *36" x 36"*
  
- PRO-04-4824 *24" x 48"*
- PRO-04-4836 *36" x 48"*
- PRO-04-4848 *48" x 48"*

**HEAVY-DUTY PROMOTIONAL BASE**

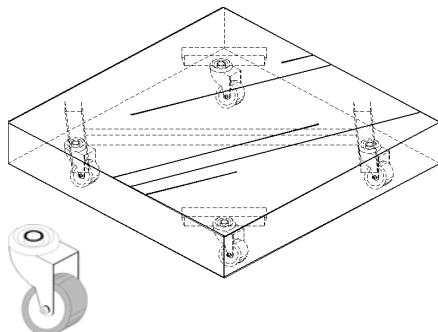

- 033-04-3838 *38" x 38" (casters not included)*
- 033-04-4343 *43" x 43" (casters not included)*
- 033-04-4848 *48" x 48" (casters not included)*
  
- 033-00-0003 *4" single caster, swivel type (unit price)*

**PROMOTIONAL SIDE PANEL (WING)**

**WITH PERFORATED MASONITE PANEL (FRONT)  
PLAIN METAL BACK, UPPER ATTACHMENT FOR  
BONI TYPE DOUBLE UPRIGHT**

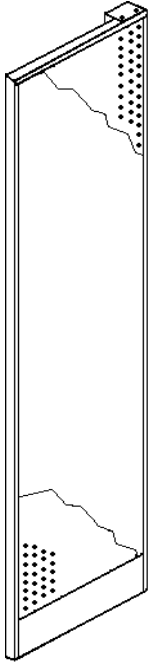

**Warning : Upper attachment not welded**

PBD-00-0753 7" x 53"(60") perforated masonite backing  
 PBD-00-0759 7" x 59"(66") perforated masonite backing  
 PBD-00-0765 7" x 65"(72") perforated masonite backing

PBD-00-0953 9" x 53"(60") perforated masonite backing  
 PBD-00-0959 9" x 59"(66") perforated masonite backing  
 PBD-00-0965 9" x 65"(72") perforated masonite backing

PBD-00-1453 14" x 53"(60") perforated masonite backing  
 PBD-00-1459 14" x 59"(66") perforated masonite backing  
 PBD-00-1465 14" x 65"(72") perforated masonite backing

PBD-00-1753 17" x 53"(60") perforated masonite backing  
 PBD-00-1759 17" x 59"(66") perforated masonite backing  
 PBD-00-1765 17" x 65"(72") perforated masonite backing

PBD-00-1953 19" x 53"(60") perforated masonite backing  
 PBD-00-1959 19" x 59"(66") perforated masonite backing  
 PBD-00-1965 19" x 65"(72") perforated masonite backing

*The Z-shaped lower attachment and self-taping screws are included.*

**WITH PERFORATED MASONITE PANEL (FRONT)  
PLAIN METAL BACK, UPPER ATTACHMENT FOR  
BONI TYPE DOUBLE UPRIGHT AND 6" DEEP  
PROTECTIVE WIRES**

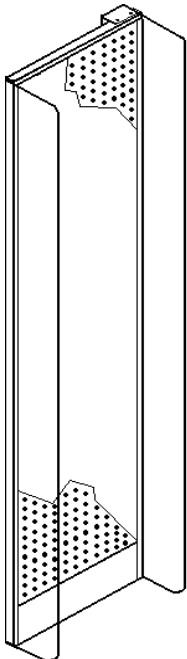

**Warning : Upper attachment not welded**

PBP-02-1453 14" x 53"(60") perforated masonite backing  
 PBP-02-1459 14" x 59"(66") perforated masonite backing  
 PBP-02-1465 14" x 65"(72") perforated masonite backing

PBP-02-1753 17" x 53"(60") perforated masonite backing  
 PBP-02-1759 17" x 59"(66") perforated masonite backing  
 PBP-02-1765 17" x 65"(72") perforated masonite backing

PBP-02-1953 19" x 53"(60") perforated masonite backing  
 PBP-02-1959 19" x 59"(66") perforated masonite backing  
 PBP-02-1965 19" x 65"(72") perforated masonite backing

*The Z-shaped lower attachment and self-taping screws are included.*

**PROMOTIONAL SIDE PANEL (WING)**

**WITH PERFORATED METAL PANEL (FRONT), PLAIN METAL BACK, UPPER ATTACHEMENT FOR BONI TYPE DOUBLE UPRIGHT**

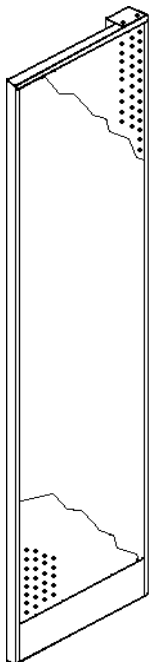

***PERFORATED METAL BACKING***

***RIGHT***

- PBM-10-1375 13" x 75½"
- PBM-10-1575 15" x 75½"
- PBM-10-1739 17" x 39½"
- PBM-10-1745 17" x 45½"
- PBM-10-1763 17" x 63½"
- PBM-10-1769 17" x 69½"
- PBM-10-1775 17" x 75½"
  
- PBM-10-2145 21" x 45½"
- PBM-10-2163 21" x 63½"
- PBM-10-2169 21" x 69½"
- PBM-10-2175 21" x 75½"
  
- PBM-10-2775 27" x 75½"
  
- PBM-10-3375 33" x 75½"

***PERFORATED METAL BACKING***

***LEFT***

- PBM-00-1375 13" x 75½"
- PBM-00-1575 15" x 75½"
- PBM-00-1739 17" x 39½"
- PBM-00-1745 17" x 45½"
- PBM-00-1763 17" x 63½"
- PBM-00-1769 17" x 69½"
- PBM-00-1775 17" x 75½"
  
- PBM-00-2145 21" x 45½"
- PBM-00-2163 21" x 63½"
- PBM-00-2169 21" x 69½"
- PBM-00-2175 21" x 75½"
  
- PBM-00-2775 27" x 75½"
  
- PBM-00-3375 33" x 75½"

*The Z-shaped lower attachment and self-taping screws are included.*

**PROMOTIONAL SIDE PANEL (WING) WITH RETURN**

**WITH PERFORATED METAL PANEL (FRONT), PLAIN METAL BACK, UPPER ATTACHEMENT FOR BONI TYPE DOUBLE UPRIGHT**

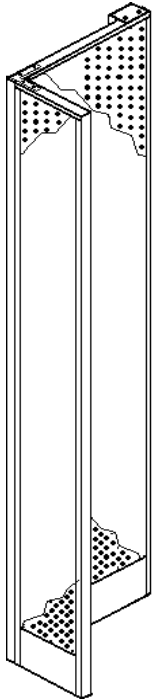

**RIGHT**

- PBM-19-1745 9" x 17" x 45½"
- PBM-19-1763 9" x 17" x 63½"
- PBM-19-1769 9" x 17" x 69½"
- PBM-19-1775 9" x 17" x 75½"
- PBM-19-1775 9" x 17" x 79½"

- PBM-19-2175 9" x 21" x 75½"

**LEFT**

- PBM-09-1745 9" x 17" x 45½"
- PBM-09-1763 9" x 17" x 63½"
- PBM-09-1769 9" x 17" x 69½"
- PBM-09-1775 9" x 17" x 75½"
- PBM-09-1775 9" x 17" x 79½"

- PBM-09-2175 9" x 21" x 75½"

*The Z-shaped lower attachment and self-taping screws are included.*

**PROMOTIONAL SIDE PANEL (WING)**

**WITH PERFORATED MASONITE PANEL PAINTED BOTH SIDES, NO BACK PANEL, UPPER ATTACHEMENT FOR BONI TYPE DOUBLE UPRIGHT**

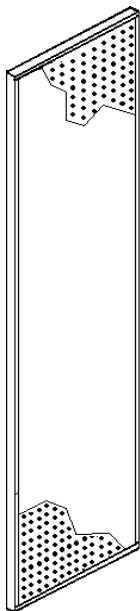

**Warning : Upper attachment not welded**

- PBS-01-1453 14" x 53"(60")
- PBS-01-1459 14" x 59"(66")
- PBS-01-1465 14" x 65"(72")

- PBS-01-1753 17" x 53"(60")
- PBS-01-1759 17" x 59"(66")
- PBS-01-1765 17" x 65"(72")

- PBS-01-1953 19" x 53"(60")
- PBS-01-1959 19" x 59"(66")
- PBS-01-1965 19" x 65"(72")

**PROMOTIONAL WIRE MESH PANEL (WING)**

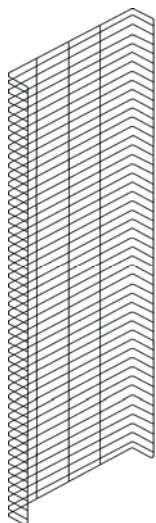

*With 2½" sides*

- 016-15-4814 14" x 48" - Painted
- 016-13-4814 14" x 48" - Chrome
- 016-13-4816 16" x 48" - Chrome

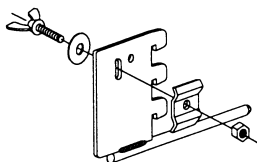

- SPB-00-0403 *Attachment for promotional wire mesh panel for end display. (with double upright only).*

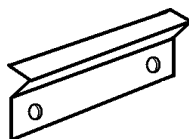

- SPB-00-0003 *Attachment for promotional wire mesh panel for endframe.*

**PROMOTIONAL WIRE MESH PANEL WIRE BASKET**

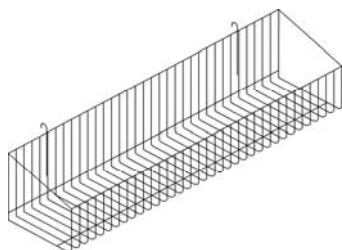

- 016-03-0002 13½" long x 3" high

**2-PIECE SINGLE HOOK**

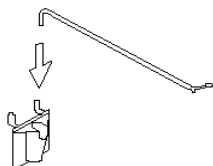

- 016-35-0002 2" (unit)

**Z-SHAPED ATTACHMENT FOR PROMOTIONAL PANEL**

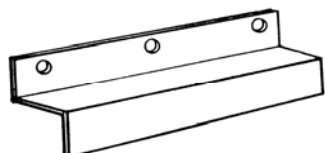

- 035-00-0002