



PRODUCT INDEX

<i>Acrylic fence</i>	I-15
<i>Acrylic fence with attachement for metal shelf</i>	I-33
<i>Bag holder</i>	I-34
<i>Basket identification</i>	I-10
<i>Basket identification plastic</i>	I-10
<i>Bookshelf bracket</i>	I-08
<i>Bracket for metal shelf</i>	I-07
<i>Bracket for wire basket</i>	I-13
<i>Bracket for wire shelf (bread/cake)</i>	I-13
<i>Bracket for wood shelf</i>	I-08
<i>Buggy with casters to move gondola</i>	I-30
<i>Canopy bracket</i>	I-30
<i>Canopy extension</i>	I-30
<i>Endless wire basket</i>	I-11, I-18
<i>Fluorescent light fixture</i>	I-31
<i>Flyer display</i>	I-28
<i>Flyer page display</i>	I-28
<i>Glass shelf 5mm</i>	I-31
<i>Glass shelf frame</i>	I-32
<i>Heavy-duty back plate for hook</i>	I-27
<i>Hook for ½" x 1½" crossbar</i>	I-27
<i>Hook for masonite and metal backing</i>	I-20 to I-25
<i>Hook for slatwall</i>	I-24 to I-26
<i>Inventory control clip</i>	I-26
<i>Kickplate drawer on casters</i>	I-33
<i>Label holder for masonite backing</i>	I-25
<i>Label holder for shelf</i>	I-09
<i>Label holder for wire basket</i>	I-10
<i>Labeling cart</i>	I-29
<i>Lighting display bracket</i>	I-34
<i>Literature holder</i>	I-19
<i>Magazine display</i>	I-18
<i>Magnet roll</i>	I-10
<i>Mica roll</i>	I-09
<i>Neon</i>	I-31
<i>Newspaper shelf</i>	I-18
<i>Plastic hand basket</i>	I-29
<i>Plastic hand basket stand</i>	I-29
<i>Plastic hook for label holder</i>	I-26
<i>Plastic label holder</i>	I-26
<i>Plastic sample hook</i>	I-27
<i>Profit strip</i>	I-19
<i>Promotional basket</i>	I-17
<i>Promotional clip</i>	I-27
<i>Road map display</i>	I-18
<i>Scan adaptor for 2-piece double hook</i>	I-26
<i>Security mirror</i>	I-29
<i>Self-adhesive plastic tab</i>	I-09
<i>Shelf with label moulding</i>	I-01, 03, 05
<i>Shelf without label moulding</i>	I-02, 04, 06
<i>Sign holder</i>	I-28
<i>Slatwall accessory steel plate</i>	I-27

PRODUCT INDEX

<i>Two-face tape roll</i>	I-10
<i>Universal clip for profit strip</i>	I-19
<i>Universal system adaptor</i>	I-33
<i>Wire basket, divider, sub-divider</i>	I-11, I-18
<i>Wire divider for metal shelf</i>	I-12
<i>Wire fence for metal shelf</i>	I-12
<i>Wire hand basket</i>	I-29
<i>Wire shelf for bread and cake</i>	I-14
<i>Wire shelf with 1" edge, moulding and brackets</i>	I-15
<i>Wire shelf with 2½" edges front/back</i>	I-12
<i>Wire shelf with 3" edge and brackets</i>	I-14
<i>Wire shelf with 3" edge and slatwall bracket</i>	I-16, I-17
<i>Wire shelf with acrylic fence, moulding and brackets</i>	I-15
<i>Wire shelf with metal bottom</i>	I-18
<i>Wire sub-divider for metal shelf</i>	I-12
<i>Wire sub-divider for wire shelf</i>	I-12

SHELF WITH LABEL MOULDING AND WITH STRAIGHT BRACKETS

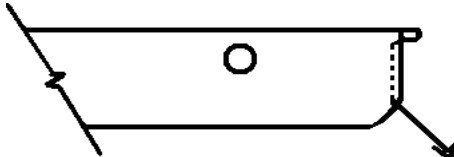
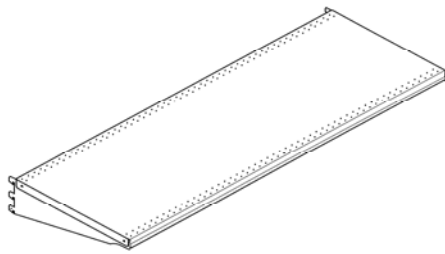

Label moulding for 1¼" high label

- TMD-01-2410 10" x 24"
- TMD-01-2412 12" x 24"
- TMD-01-2414 14" x 24"
- TMD-01-2416 16" x 24"
- TMD-01-2418 18" x 24"
- TMD-01-2420 20" x 24"
- TMD-01-2422 22" x 24"
- TMD-01-2424 24" x 24"
- TMD-01-2426 26" x 24"
- TMD-01-2428 28" x 24"
- TMD-01-2430 30" x 24"

-
- TMD-01-3010 10" x 30"
 - TMD-01-3012 12" x 30"
 - TMD-01-3014 14" x 30"
 - TMD-01-3016 16" x 30"
 - TMD-01-3018 18" x 30"
 - TMD-01-3020 20" x 30"
 - TMD-01-3022 22" x 30"
 - TMD-01-3024 24" x 30"
 - TMD-01-3026 26" x 30"
 - TMD-01-3028 28" x 30"
 - TMD-01-3030 30" x 30"

-
- TMD-01-3610 10" x 36"
 - TMD-01-3612 12" x 36"
 - TMD-01-3614 14" x 36"
 - TMD-01-3616 16" x 36"
 - TMD-01-3618 18" x 36"
 - TMD-01-3620 20" x 36"
 - TMD-01-3622 22" x 36"
 - TMD-01-3624 24" x 36"
 - TMD-01-3626 26" x 36"
 - TMD-01-3628 28" x 36"
 - TMD-01-3630 30" x 36"

-
- TMD-01-4810 10" x 48"
 - TMD-01-4812 12" x 48"
 - TMD-01-4814 14" x 48"
 - TMD-01-4816 16" x 48"
 - TMD-01-4818 18" x 48"
 - TMD-01-4820 20" x 48"
 - TMD-01-4822 22" x 48"
 - TMD-01-4824 24" x 48"
 - TMD-01-4826 26" x 48"
 - TMD-01-4828 28" x 48"
 - TMD-01-4830 30" x 48"

SHELF WITHOUT LABEL MOULDING AND WITH STRAIGHT BRACKETS

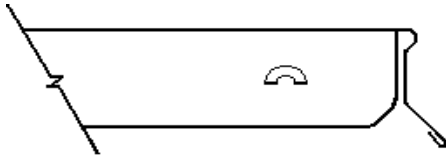
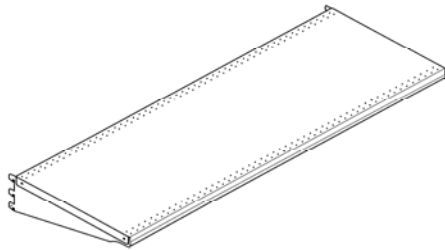

TSD-01-2410	10" x 24"
TSD-01-2412	12" x 24"
TSD-01-2414	14" x 24"
TSD-01-2416	16" x 24"
TSD-01-2418	18" x 24"
TSD-01-2420	20" x 24"
TSD-01-2422	22" x 24"
TSD-01-2424	24" x 24"
TSD-01-2426	26" x 24"
TSD-01-2428	28" x 24"
TSD-01-2430	30" x 24"

TSD-01-3010	10" x 30"
TSD-01-3012	12" x 30"
TSD-01-3014	14" x 30"
TSD-01-3016	16" x 30"
TSD-01-3018	18" x 30"
TSD-01-3020	20" x 30"
TSD-01-3022	22" x 30"
TSD-01-3024	24" x 30"
TSD-01-3026	26" x 30"
TSD-01-3028	28" x 30"
TSD-01-3030	30" x 30"

TSD-01-3610	10" x 36"
TSD-01-3612	12" x 36"
TSD-01-3614	14" x 36"
TSD-01-3616	16" x 36"
TSD-01-3618	18" x 36"
TSD-01-3620	20" x 36"
TSD-01-3622	22" x 36"
TSD-01-3624	24" x 36"
TSD-01-3626	26" x 36"
TSD-01-3628	28" x 36"
TSD-01-3630	30" x 36"

TSD-01-4810	10" x 48"
TSD-01-4812	12" x 48"
TSD-01-4814	14" x 48"
TSD-01-4816	16" x 48"
TSD-01-4818	18" x 48"
TSD-01-4820	20" x 48"
TSD-01-4822	22" x 48"
TSD-01-4824	24" x 48"
TSD-01-4826	26" x 48"
TSD-01-4828	28" x 48"
TSD-01-4830	30" x 48"

SHELF WITH LABEL MOULDING AND WITH ADJUSTABLE BRACKETS

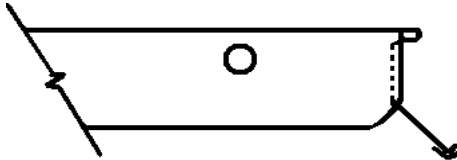
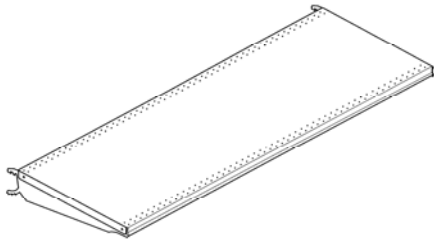

Label moulding for 1 1/4" high label

TMI-01-2406	6" x 24"
TMI-01-2408	8" x 24"
TMI-01-2410	10" x 24"
TMI-01-2412	12" x 24"
TMI-01-2414	14" x 24"
TMI-01-2416	16" x 24"
TMI-01-2418	18" x 24"
TMI-01-2420	20" x 24" (with heavy-duty brackets)
TMI-01-2422	22" x 24" (with heavy-duty brackets)

TMI-01-3006	6" x 30"
TMI-01-3008	8" x 30"
TMI-01-3010	10" x 30"
TMI-01-3012	12" x 30"
TMI-01-3014	14" x 30"
TMI-01-3016	16" x 30"
TMI-01-3018	18" x 30"
TMI-01-3020	20" x 30" (with heavy-duty brackets)
TMI-01-3022	22" x 30" (with heavy-duty brackets)

TMI-01-3606	6" x 36"
TMI-01-3608	8" x 36"
TMI-01-3610	10" x 36"
TMI-01-3612	12" x 36"
TMI-01-3614	14" x 36"
TMI-01-3616	16" x 36"
TMI-01-3618	18" x 36"
TMI-01-3620	20" x 36" (with heavy-duty brackets)
TMI-01-3622	22" x 36" (with heavy-duty brackets)

TMI-01-4806	6" x 48"
TMI-01-4808	8" x 48"
TMI-01-4810	10" x 48"
TMI-01-4812	12" x 48"
TMI-01-4814	14" x 48"
TMI-01-4816	16" x 48"
TMI-01-4818	18" x 48"
TMI-01-4820	20" x 48" (with heavy-duty brackets)
TMI-01-4822	22" x 48" (with heavy-duty brackets)

SHELF WITHOUT LABEL MOULDING AND WITH ADJUSTABLE BRACKETS

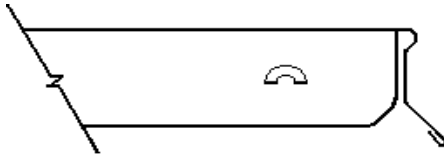
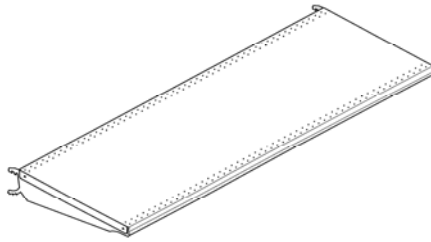

TSI-01-2406	6" x 24"
TSI-01-2408	8" x 24"
TSI-01-2410	10" x 24"
TSI-01-2412	12" x 24"
TSI-01-2414	14" x 24"
TSI-01-2416	16" x 24"
TSI-01-2418	18" x 24"
TSI-01-2420	20" x 24" (with heavy-duty brackets)
TSI-01-2422	22" x 24" (with heavy-duty brackets)

TSI-01-3006	6" x 30"
TSI-01-3008	8" x 30"
TSI-01-3010	10" x 30"
TSI-01-3012	12" x 30"
TSI-01-3014	14" x 30"
TSI-01-3016	16" x 30"
TSI-01-3018	18" x 30"
TSI-01-3020	20" x 30" (with heavy-duty brackets)
TSI-01-3022	22" x 30" (with heavy-duty brackets)

TSI-01-3606	6" x 36"
TSI-01-3608	8" x 36"
TSI-01-3610	10" x 36"
TSI-01-3612	12" x 36"
TSI-01-3614	14" x 36"
TSI-01-3616	16" x 36"
TSI-01-3618	18" x 36"
TSI-01-3620	20" x 36" (with heavy-duty brackets)
TSI-01-3622	22" x 36" (with heavy-duty brackets)

TSI-01-4806	6" x 48"
TSI-01-4808	8" x 48"
TSI-01-4810	10" x 48"
TSI-01-4812	12" x 48"
TSI-01-4814	14" x 48"
TSI-01-4816	16" x 48"
TSI-01-4818	18" x 48"
TSI-01-4820	20" x 48" (with heavy-duty brackets)
TSI-01-4822	22" x 48" (with heavy-duty brackets)

SHELF WITH LABEL MOULDING (BRACKETS NOT INCLUDED)

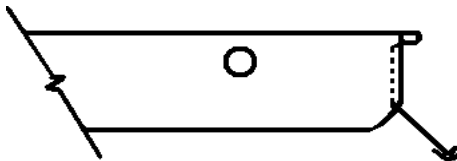
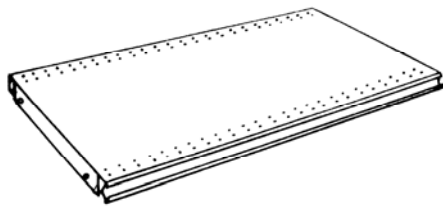

Label moulding for 1¼" high label

005-03-2406	6" x 24"
005-03-2408	8" x 24"
005-03-2410	10" x 24"
005-03-2412	12" x 24"
005-03-2414	14" x 24"
005-03-2416	16" x 24"
005-03-2418	18" x 24"
005-03-2420	20" x 24"
005-03-2422	22" x 24"
005-03-2424	24" x 24"
005-03-2426	26" x 24"
005-03-2428	28" x 24"
005-03-2430	30" x 24"

005-03-3006	6" x 30"
005-03-3008	8" x 30"
005-03-3010	10" x 30"
005-03-3012	12" x 30"
005-03-3014	14" x 30"
005-03-3016	16" x 30"
005-03-3018	18" x 30"
005-03-3020	20" x 30"
005-03-3022	22" x 30"
005-03-3024	24" x 30"
005-03-3026	26" x 30"
005-03-3028	28" x 30"
005-03-3030	30" x 30"

005-03-3606	6" x 36"
005-03-3608	8" x 36"
005-03-3610	10" x 36"
005-03-3612	12" x 36"
005-03-3614	14" x 36"
005-03-3616	16" x 36"
005-03-3618	18" x 36"
005-03-3620	20" x 36"
005-03-3622	22" x 36"
005-03-3624	24" x 36"
005-03-3626	26" x 36"
005-03-3628	28" x 36"
005-03-3630	30" x 36"

005-03-4806	6" x 48"
005-03-4808	8" x 48"
005-03-4810	10" x 48"
005-03-4812	12" x 48"
005-03-4814	14" x 48"
005-03-4816	16" x 48"
005-03-4818	18" x 48"
005-03-4820	20" x 48"
005-03-4822	22" x 48"
005-03-4824	24" x 48"
005-03-4826	26" x 48"
005-03-4828	28" x 48"
005-03-4830	30" x 48"

SHELF WITHOUT LABEL MOULDING (BRACKETS NOT INCLUDED)

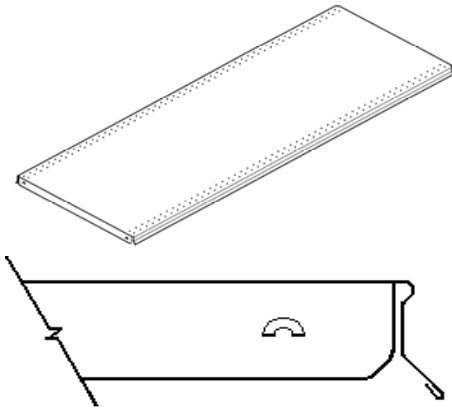

005-01-2406	6" x 24"
005-01-2408	8" x 24"
005-01-2410	10" x 24"
005-01-2412	12" x 24"
005-01-2414	14" x 24"
005-01-2416	16" x 24"
005-01-2418	18" x 24"
005-01-2420	20" x 24"
005-01-2422	22" x 24"
005-01-2424	24" x 24"
005-01-2426	26" x 24"
005-01-2428	28" x 24"
005-01-2430	30" x 24"

005-01-3006	6" x 30"
005-01-3008	8" x 30"
005-01-3010	10" x 30"
005-01-3012	12" x 30"
005-01-3014	14" x 30"
005-01-3016	16" x 30"
005-01-3018	18" x 30"
005-01-3020	20" x 30"
005-01-3022	22" x 30"
005-01-3024	24" x 30"
005-01-3026	26" x 30"
005-01-3028	28" x 30"
005-01-3030	30" x 30"

005-01-3606	6" x 36"
005-01-3608	8" x 36"
005-01-3610	10" x 36"
005-01-3612	12" x 36"
005-01-3614	14" x 36"
005-01-3616	16" x 36"
005-01-3618	18" x 36"
005-01-3620	20" x 36"
005-01-3622	22" x 36"
005-01-3624	24" x 36"
005-01-3626	26" x 36"
005-01-3628	28" x 36"
005-01-3630	30" x 36"

005-01-4806	6" x 48"
005-01-4808	8" x 48"
005-01-4810	10" x 48"
005-01-4812	12" x 48"
005-01-4814	14" x 48"
005-01-4816	16" x 48"
005-01-4818	18" x 48"
005-01-4820	20" x 48"
005-01-4822	22" x 48"
005-01-4824	24" x 48"
005-01-4826	26" x 48"
005-01-4828	28" x 48"
005-01-4830	30" x 48"

STRAIGHT BRACKET FOR SHELF WITH LABEL MOULDING

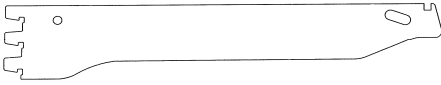
	006-00-0010	10"
	006-00-0012	12"
	006-00-0014	14"
	006-00-0016	16"
	006-00-0018	18"
	006-00-0020	20"
	006-00-0022	22"
	006-00-0024	24"
	006-00-0026	26"
	006-00-0028	28" <i>heavy-duty</i>
	006-00-0030	30" <i>heavy-duty</i>

STRAIGHT BRACKET FOR SHELF WITHOUT LABEL MOULDING

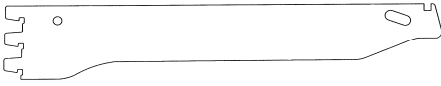
	006-01-0010	10" (10½")
	006-01-0012	12" (12½")
	006-01-0014	14" (14½")
	006-01-0016	16" (16½")
	006-01-0018	18" (18½")
	006-01-0020	20" (20½")
	006-01-0022	22" (22½")
	006-01-0024	24" (24½")
	006-01-0026	26" (26½")
	006-01-0028	28" (28½") <i>heavy-duty</i>
	006-01-0030	30" (30½") <i>heavy-duty</i>

ADJUSTABLE BRACKET

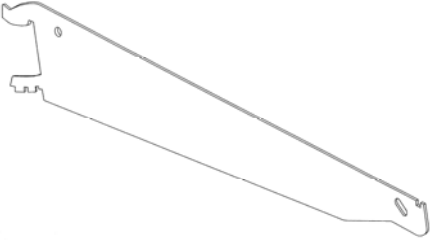
	006-02-0006	6"
	006-02-0008	8"
	006-02-0010	10"
	006-02-0012	12"
	006-02-0014	14"
	006-02-0016	16"
	006-02-0018	18"

HEAVY DUTY ADJUSTABLE BRACKET

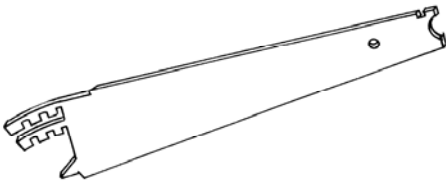
	006-19-0016	16"
	006-19-0018	18"
	006-19-0020	20"
	006-19-0022	22"
	006-19-0024	24"

STRAIGHT WOOD SHELF BRACKET



- 006-G4-0006 6" Left
- 006-G4-0008 8" Left
- 006-G4-0010 10" Left
- 006-G4-0012 12" Left
- 006-G4-0014 14" Left

- 006-G4-0016 16" Left
- 006-G4-0018 18" Left
- 006-G4-0020 20" Left

-
- 006-D4-0006 6" Right
 - 006-D4-0008 8" Right
 - 006-D4-0010 10" Right
 - 006-D4-0012 12" Right
 - 006-D4-0014 14" Right

 - 006-D4-0016 16" Right
 - 006-D4-0018 18" Right
 - 006-D4-0020 20" Right

ADJUSTABLE WOOD SHELF BRACKET

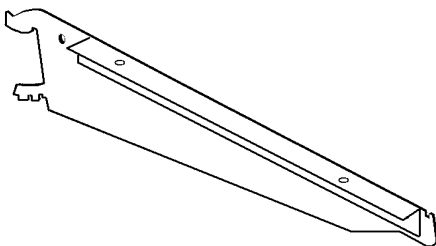

- 006-G4-0106 6" Left
- 006-G4-0108 8" Left
- 006-G4-0110 10" Left
- 006-G4-0112 12" Left
- 006-G4-0114 14" Left

- 006-G4-0116 16" Left - heavy-duty
- 006-G4-0118 18" Left - heavy-duty
- 006-G4-0120 20" Left - heavy-duty

-
- 006-D4-0106 6" Right
 - 006-D4-0108 8" Right
 - 006-D4-0110 10" Right
 - 006-D4-0112 12" Right
 - 006-D4-0114 14" Right

 - 006-D4-0116 16" Right - heavy-duty
 - 006-D4-0118 18" Right - heavy-duty
 - 006-D4-0120 20" Right - heavy-duty

BOOKSHELF BRACKET

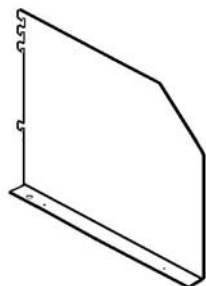

PACK OF 5 PAIRS

- SB797-121034 12" deep x 10 3/4" high - Left and right

PACK OF 25 PAIRS

- SB797-121034 12" deep x 10 3/4" high - Left and right

SELF-ADHESIVE PLASTIC LABEL HOLDER

15° ANGLE

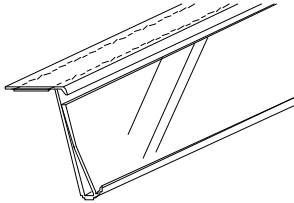

011-11-1524 24"
011-11-1530 30"

011-11-1536 36"
011-11-1548 48"

90° ANGLE

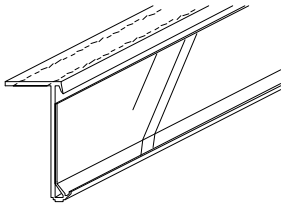

011-11-9024 24"
011-11-9030 30"

011-11-9036 36"
011-11-9048 48"

FOR FLAT SURFACE

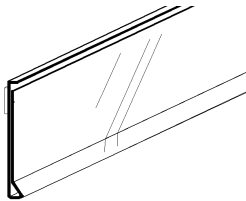

011-02-0348C 48" clear backing (34WCL48)

PLASTIC LABEL HOLDER FOR SHELF WITH LABEL MOULDING



011-13-2524 24" clear backing
011-13-2530 30" clear backing

011-13-2536 36" clear backing
011-13-2548 48" clear backing

1 1/4" x 500' ROLL OF MICA

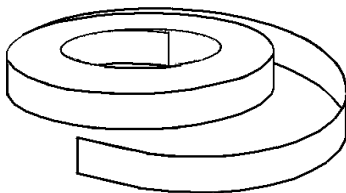

011-11-0001 Clear

011-11-0001B Blue
011-11-0001R Red
011-11-0001V Green

SELF-ADHESIVE PLASTIC TAB

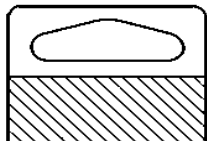

CLUSTERTAB6116 1 5/8" wide x 1/4" high
Model 6116 (pack of 200 pcs)

LABEL HOLDER FOR WIRE MESH BASKET AND WIRE SHELF

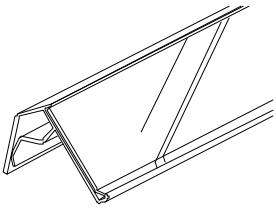

011-11-4503 45° angle, 3" long

BASKET METAL IDENTIFICATION

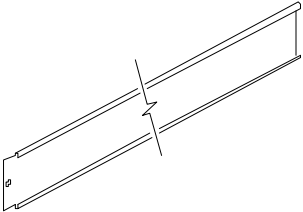

016-05-0036 3" x 36"

016-05-0048 3" x 48"

CLEAR PLASTIC FOR BASKET IDENTIFICATION

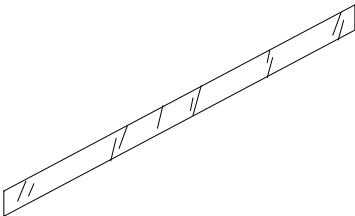

016-05-0136 36"

016-05-0148 48"

MAGNET ROLL

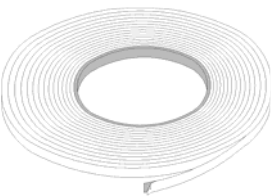

011-15-0001 ½" x 100' - self-adhesive backing

011-15-0002 ¾" x 100' - self-adhesive backing

Price as per request, special order

2-FACE SELF-ADHESIVE TAPE

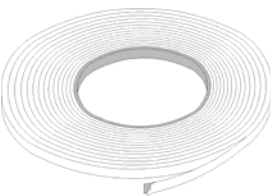

011-15-0101 ¾" x 100'

ENDLESS WIRE MESH BASKET

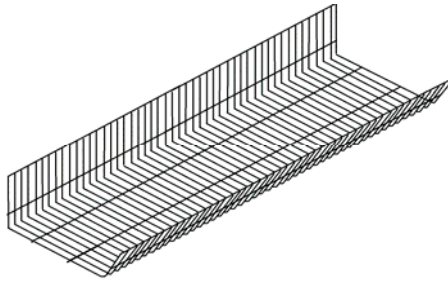

016-03-2412 12" x 24"
016-03-2416 16" x 24"

016-03-3012 12" x 30"
016-03-3014 14" x 30"
016-03-3016 16" x 30"

016-03-3612 12" x 36"
016-03-3614 14" x 36"
016-03-3616 16" x 36"

016-03-3618 18" x 36"
016-03-3620 20" x 36"
016-03-3622 22" x 36"

016-03-4812 12" x 48"
016-03-4814 14" x 48"
016-03-4816 16" x 48"

016-03-4818 18" x 48"
016-03-4820 20" x 48"
016-03-4822 22" x 48"

WIRE MESH BASKET DIVIDER

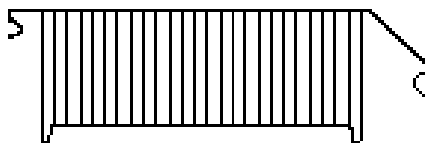

Length in parenthesis,
represents the
dimension of the
bottom of the basket

016-04-0012 6" x 12" (9½")
016-04-0014 6" x 14" (11½")
016-04-0016 6" x 16" (13½")

016-04-0018 6" x 18" (15½")
016-04-0020 6" x 20" (17½")
016-04-0022 6" x 22" (19½")

WIRE MESH BASKET SUB-DIVIDER

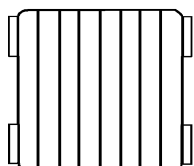

016-04-0004 6" x 4"

016-04-0006 6" x 6"

WIRE DIVIDER FOR METAL SHELF

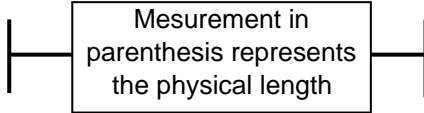
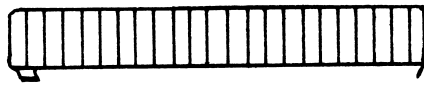

- 016-02-0012 2½" high x 12" (10½")
- 016-02-0014 2½" high x 14" (12½")
- 016-02-0016 2½" high x 16" (14½")
- 016-02-0018 2½" high x 18" (16½")
- 016-02-0020 2½" high x 20" (18½")
- 016-02-0022 2½" high x 22" (20½")
- 016-02-0124 2½" high x 24" (22½")

WIRE FENCE FOR METAL SHELF



- 016-02-0024 24" x 2½" high
- 016-02-0030 30" x 2½" high
- 016-02-0036 36" x 2½" high
- 016-02-0048 48" x 2½" high

WIRE SUBDIVIDER FOR METAL SHELF



- 016-02-0004 4" x 2½" high - **CHROME finish**
- 016-02-0006 6" x 2½" high - **CHROME finish**

WIRE SHELF WITH 2½" EDGE FRONT AND BACK



- 016-13-4814 14" x 48"- **CHROME finish**
- 016-13-4816 16" x 48"- **CHROME finish**

WIRE SUBDIVIDER FOR WIRE SHELF

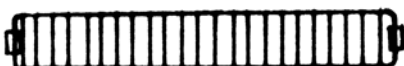

- 016-13-0214 14" x 2½" high - **CHROME finish**
- 016-13-0216 16" x 2½" high - **CHROME finish**

STRAIGHT BRACKET FOR WIRE BASKET AND WIRE SHELF

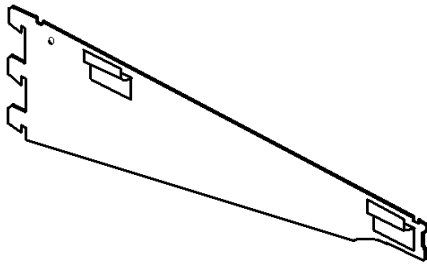

- 006-G5-0010 10" (8") left
- 006-G5-0012 12" (10") left
- 006-G5-0014 14" (12") left
- 006-G5-0016 16" (14") left
- 006-G5-0018 18" (16") left
- 006-G5-0020 20" (18") left

-
- 006-D5-0010 10" (8") right
 - 006-D5-0012 12" (10") right
 - 006-D5-0014 14" (12") right
 - 006-D5-0016 16" (14") right
 - 006-D5-0018 18" (16") right
 - 006-D5-0020 20" (18") right

ADJUSTABLE BRACKET FOR WIRE BASKET AND WIRE SHELF

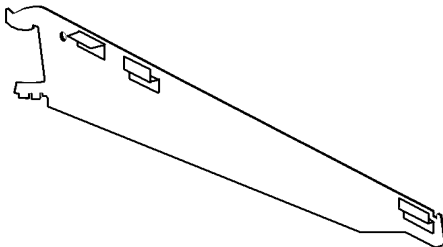

- 006-G5-0110 10" (8") left
- 006-G5-0112 12" (10") left
- 006-G5-0114 14" (12") left
- 006-G5-0116 16" (14") left

-
- 006-D5-0110 10" (8") right
 - 006-D5-0112 12" (10") right
 - 006-D5-0114 14" (12") right
 - 006-D5-0116 16" (14") right

HEAVY-DUTY ADJUSTABLE BRACKET FOR WIRE BASKET AND WIRE SHELF



- 006-G5-0118 18" left
- 006-G5-0120 20" left
- 006-G5-0122 22" left
- 006-G5-0124 24" left

-
- 006-D5-0118 18" right
 - 006-D5-0120 20" right
 - 006-D5-0122 22" right
 - 006-D5-0124 24" right

HEAVY-DUTY ADJUSTABLE BRACKET FOR WIRE SHELF (BREAD & CAKE)



- 006-11-G-018 18" left
- 006-11-G-020 20" left
- 006-11-G-022 22" left

-
- 006-11-D-018 18" right
 - 006-11-D-020 20" right
 - 006-11-D-022 22" right

WIRE SHELF FOR BREAD AND CAKE - CHROME FINISH

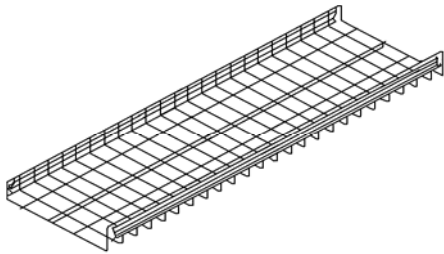

- 016-01-3620 20" x 36"
- 016-01-3622 22" x 36"

- 016-01-4818 18" x 48"
- 016-01-4820 20" x 48"
- 016-01-4822 22" x 48"

WIRE SHELF WITH 3" FRONT EDGE AND BRACKETS

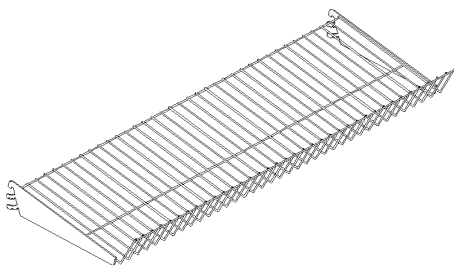

- 090-16-2408 8" x 24"
- 090-16-2410 10" x 24"
- 090-16-2412 12" x 24"

- 090-16-3008 8" x 30"
- 090-16-3010 10" x 30"
- 090-16-3012 12" x 30"

- 090-16-3608 8" x 36"
- 090-16-3610 10" x 36"
- 090-16-3612 12" x 36"

WIRE SHELF WITH 3" FRONT EDGE, MOULDING AND BRACKETS

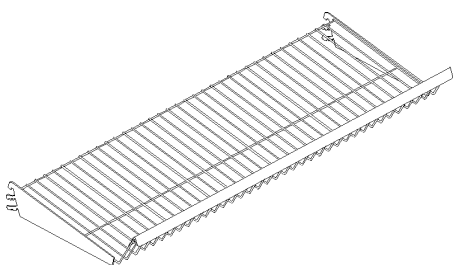

- 090-17-2408 8" x 24"
- 090-17-2410 10" x 24"
- 090-17-2412 12" x 24"

- 090-17-3008 8" x 30"
- 090-17-3010 10" x 30"
- 090-17-3012 12" x 30"

- 090-17-3608 8" x 36"
- 090-17-3610 10" x 36"
- 090-17-3612 12" x 36"

WIRE SHELF WITH 1" FRONT EDGE, MOULDING AND BRACKETS

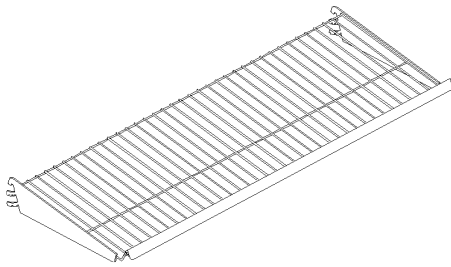

090-22-2404	4" x 24"
090-22-2406	6" x 24"
090-22-2408	8" x 24"
090-22-2410	10" x 24"
090-22-2412	12" x 24"
090-22-3004	4" x 30"
090-22-3006	6" x 30"
090-22-3008	8" x 30"
090-22-3010	10" x 30"
090-22-3012	12" x 30"
090-22-3604	4" x 36"
090-22-3606	6" x 36"
090-22-3608	8" x 36"
090-22-3610	10" x 36"
090-22-3612	12" x 36"

WIRE SHELF WITH BRACKETS AND MOULDING FOR ACRYLIC FENCE

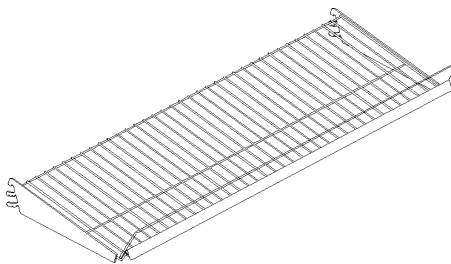

090-23-2404	4" x 24"
090-23-2406	6" x 24"
090-23-2408	8" x 24"
090-23-2410	10" x 24"
090-23-2412	12" x 24"
090-23-3004	4" x 30"
090-23-3006	6" x 30"
090-23-3008	8" x 30"
090-23-3010	10" x 30"
090-23-3012	12" x 30"
090-23-3604	4" x 36"
090-23-3606	6" x 36"
090-23-3608	8" x 36"
090-23-3610	10" x 36"
090-23-3612	12" x 36"

ACRYLIC FENCE FOR WIRE SHELF



090-36-2403	1/8" x 3" x 24"
090-36-3003	1/8" x 3" x 30"
090-36-3603	1/8" x 3" x 36"

WIRE SHELF FOR SLATWALL WITH 3" FRONT EDGE

WITH STRAIGHT BRACKET

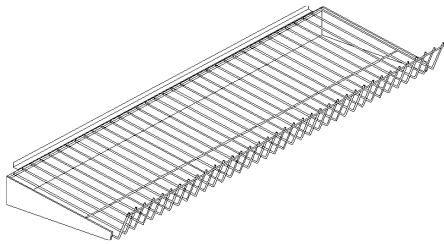

090-18-2408 8" x 24" for slatwall
 090-18-2410 10" x 24" for slatwall
 090-18-2412 12" x 24" for slatwall

090-18-3008 8" x 30" for slatwall
 090-18-3010 10" x 30" for slatwall
 090-18-3012 12" x 30" for slatwall

090-18-3608 8" x 36" for slatwall
 090-18-3610 10" x 36" for slatwall
 090-18-3612 12" x 36" for slatwall

WITH SLANTED BRACKET

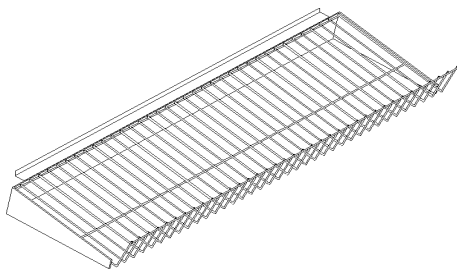

090-19-2408 8" x 24" for slatwall
 090-19-2410 10" x 24" for slatwall
 090-19-2412 12" x 24" for slatwall

090-19-3008 8" x 30" for slatwall
 090-19-3010 10" x 30" for slatwall
 090-19-3012 12" x 30" for slatwall

090-19-3608 8" x 36" for slatwall
 090-19-3610 10" x 36" for slatwall
 090-19-3612 12" x 36" for slatwall

WITH STRAIGHT BRACKET AND MOULDING

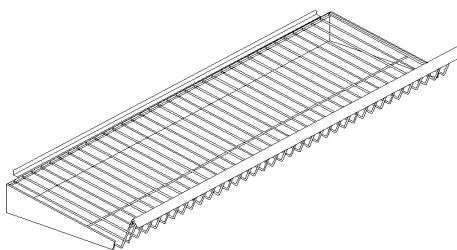

090-20-2408 8" x 24" for slatwall
 090-20-2410 10" x 24" for slatwall
 090-20-2412 12" x 24" for slatwall

090-20-3008 8" x 30" for slatwall
 090-20-3010 10" x 30" for slatwall
 090-20-3012 12" x 30" for slatwall

090-20-3608 8" x 36" for slatwall
 090-20-3610 10" x 36" for slatwall
 090-20-3612 12" x 36" for slatwall

WIRE SHELF FOR SLATWALL WITH 3" FRONT EDGE

WITH SLANTED BRACKET AND MOULDING

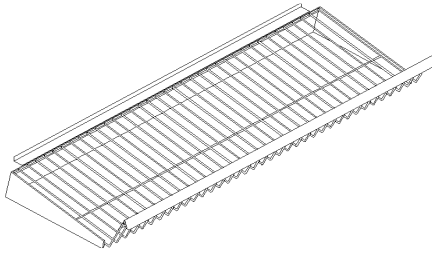

090-21-2408	8" x 24" for slatwall
090-21-2410	10" x 24" for slatwall
090-21-2412	12" x 24" for slatwall
090-21-3008	8" x 30" for slatwall
090-21-3010	10" x 30" for slatwall
090-21-3012	12" x 30" for slatwall
090-21-3608	8" x 36" for slatwall
090-21-3610	10" x 36" for slatwall
090-21-3612	12" x 36" for slatwall

33" HIGH PROMOTIONAL BASKET WITH SIGN HOLDER

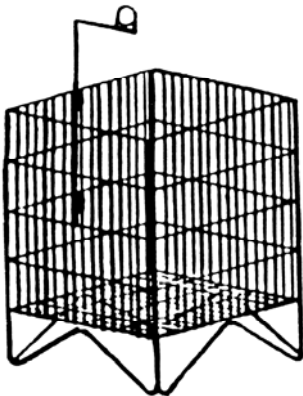

016-08-1414	14" x 14" chrome finish
016-08-1814	14" x 18" chrome finish
016-08-1818	18" x 18" chrome finish
016-08-2424	24" x 24" chrome finish

SMALL ENDLESS WIRE BASKET



016-06-0001 8" x 16" x 5"

016-06-0002 4" x 6" divider for small basket

WIRE SHELF WITH METAL BOTTOM

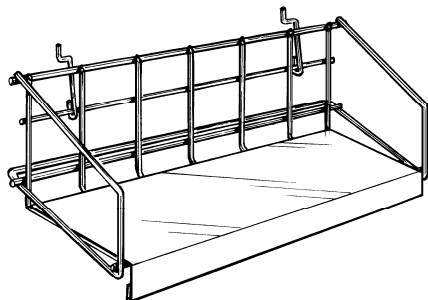

016-27-0001 7" x 6" x 16"

NEWSPAPER SHELF

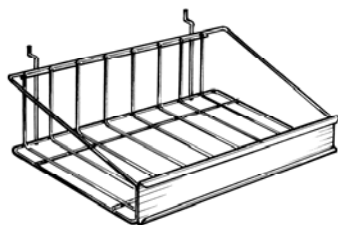

13" x 16"

090-07-0016 for perforated backing

090-07-0116 for slatwall backing

8½" x 11" MAGAZINE DISPLAY

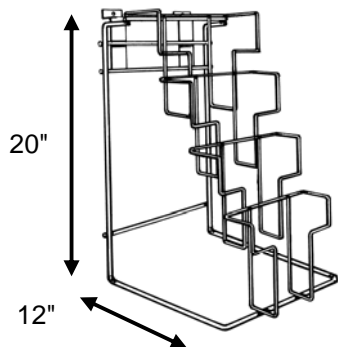

FOR PERFORATED MASONITE

090-08-0101 4-tier, 20" high - upper section

090-08-0102 3-tier, 16" high - lower section

FOR SLATWALL

090-08-0101S 4-tier, 20" high - upper section

090-08-0102S 3-tier, 16" high - lower section

ROAD MAP DISPLAY

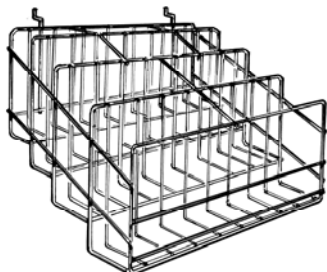

FOR PERFORATED MASONITE

090-08-0001 16" long x 13" high x 12" deep - 4-tier

FOR SLATWALL

090-08-0001S 16" long x 13" high x 12" deep - 4-tier

ONE-PIECE LITERATURE HOLDER

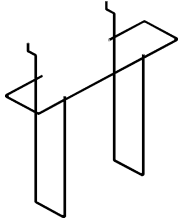

- 017-03-0705 5" x 7"
- 017-03-1108 8½" x 11"

PROFIT STRIP

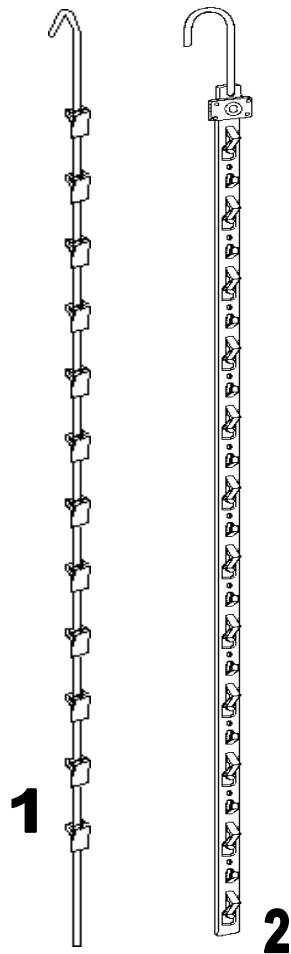

- 016-14-0032 12 clips, cane type (no. 1)
unit price
box of 100 pieces, (1 to 10)
box of 100 pieces, (10 and more)
- 016-14-0131 Thin metal with label holder steel plate
(no. 2) (price per unit)
- 016-14-1131 Thin metal with label holder steel plate
(no. 2) (box of 100 pieces)

UNIVERSAL CLIP FOR PROFIT STRIP

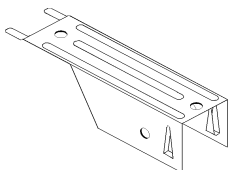

- 016-14-0102

SINGLE HOOK FOR MASONITE BACKING

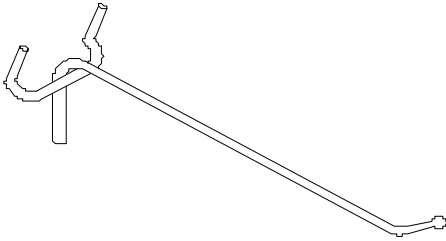

016-30-0002	2" box of 100
016-30-0004	4" box of 100
016-30-0006	6" box of 100
016-30-0008	8" box of 100
016-30-0010	10" box of 100
016-30-0012	12" box of 100

2" / rod = 0.148"

4" / rod = 0.187"

6" / rod = 0.187"

8" / rod = 0.187"

10" / rod = 0.187"

12" / rod = 0.225"

SINGLE HOOK FOR METAL BACKING

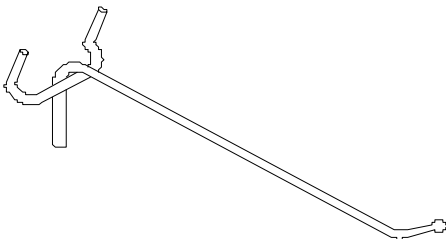

016-30-1002	2" box of 100, for metal backing
016-30-1004	4" box of 100, for metal backing
016-30-1006	6" box of 100, for metal backing
016-30-1008	8" box of 100, for metal backing
016-30-1010	10" box of 100, for metal backing
016-30-1012	12" box of 100, for metal backing

(for perforated metal backing)

2" / rod = 0.148"

4" / rod = 0.187"

6" / rod = 0.187"

8" / rod = 0.187"

10" / rod = 0.187"

12" / rod = 0.225"

DOUBLE HOOK FOR MASONITE BACKING

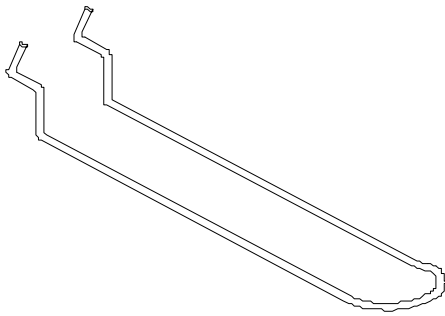

- 016-31-0004 4" box of 100
- 016-31-0006 6" box of 100
- 016-31-0008 8" box of 100
- 016-31-0010 10" box of 100
- 016-31-0012 12" box of 100

4" / rod = 0.148"

6" / rod = 0.148"

8" / rod = 0.148"

10" / rod = 0.187"

12" / rod = 0.187"

DOUBLE HOOK FOR METAL BACKING

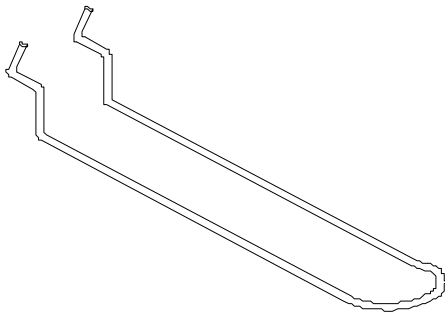

- 016-31-1004 4" box of 100, for metal backing
- 016-31-1006 6" box of 100, for metal backing
- 016-31-1008 8" box of 100, for metal backing
- 016-31-1010 10" box of 100, for metal backing
- 016-31-1012 12" box of 100, for metal backing

(for perforated metal backing)

4" / rod = 0.148"

6" / rod = 0.148"

8" / rod = 0.148"

10" / rod = 0.187"

12" / rod = 0.187"

SINGLE SCAN HOOK FOR MASONITE BACKING

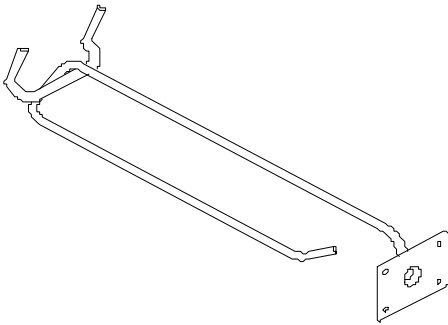

- 016-32-0004 4" box of 100
- 016-32-0006 6" box of 100
- 016-32-0008 8" box of 100
- 016-32-0011 11" box of 100

4" / rod = 0.187"

6" / rod = 0.187"

8" / rod = 0.187"

11" / rod = 0.225"

SINGLE SCAN HOOK FOR METAL BACKING

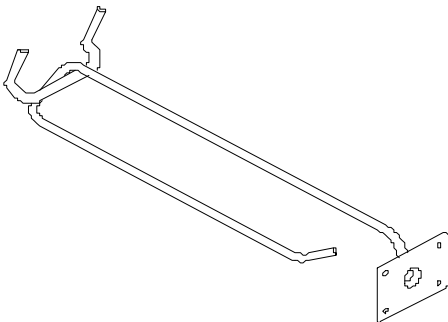

- 016-32-1004 4" box of 100, for metal backing
- 016-32-1006 6" box of 100, for metal backing
- 016-32-1008 8" box of 100, for metal backing
- 016-32-1011 11" box of 100, for metal backing

(for perforated metal backing)

4" / rod = 0.187"

6" / rod = 0.187"

8" / rod = 0.187"

11" / rod = 0.225"

DOUBLE SCAN HOOK FOR MASONITE AND METAL BACKING

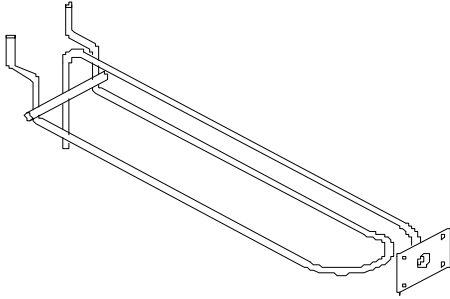

- | | |
|-------------|----------------|
| 016-33-0004 | 4" box of 100 |
| 016-33-0006 | 6" box of 100 |
| 016-33-0008 | 8" box of 100 |
| 016-33-0012 | 12" box of 100 |

4" / rod = 0.148"

6" / rod = 0.148"

8" / rod = 0.148"

11" / rod = 0.187"

2-PIECE SINGLE SCAN HOOK FOR MASONITE AND METAL BACKING

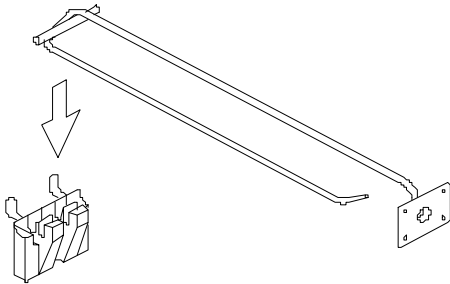

- | | |
|-------------|----------------|
| 016-36-0002 | 2" box of 100 |
| 016-36-0004 | 4" box of 100 |
| 016-36-0006 | 6" box of 100 |
| 016-36-0008 | 8" box of 100 |
| 016-36-0011 | 11" box of 100 |

4" / rod = 0.187"

6" / rod = 0.187"

8" / rod = 0.187"

11" / rod = 0.225"

2-PIECE SINGLE HOOK FOR MASONITE AND METAL BACKING

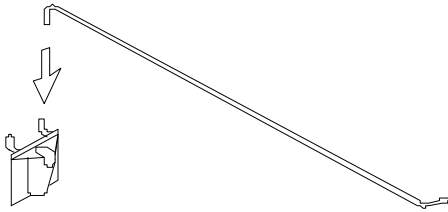

016-35-0002	2" UNIT
016-35-0004	4" box of 100
016-35-0006	6" box of 100
016-35-0008	8" box of 100
016-35-0012	12" box of 100

2" / rod = 0.187"

4" / rod = 0.187"

6" / rod = 0.187"

8" / rod = 0.187"

11" / rod = 0.225"

SINGLE SCAN HOOK FOR SLATWALL - ZINC FINISH

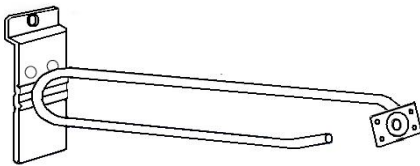

016-37-0004	4" box of 100
016-37-0006	6" box of 100
016-37-0008	8" box of 100
016-37-0011	11" box of 100

4" / rod = 0.187"

6" / rod = 0.187"

8" / rod = 0.187"

11" / rod = 0.225"

SINGLE SCAN HOOK FOR SLATWALL - PAINTED BLACK

CODE FOR UNIT PRICE

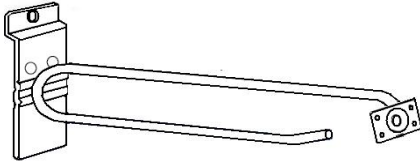

044-16-0104U	4"
044-16-0106U	6"
044-16-0108U	8"
044-16-0110U	11"

CODE FOR BOX OF 100

4" / rod = 0.187"
 6" / rod = 0.187"
 8" / rod = 0.187"
 11" / rod = 0.225"

044-16-0104	4" box of 100
044-16-0106	6" box of 100
044-16-0108	8" box of 100
044-16-0110	11" box of 100

LABEL HOLDER HOOK FOR MASONITE BACKING

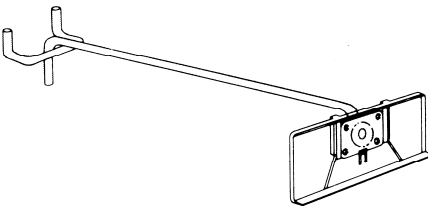

016-43-0004	4" box of 100
016-43-0006	6" box of 100
016-43-0008	8" box of 100
016-43-0012	12" box of 100

Label holder not included - see page I-26

2-PIECE DOUBLE HOOK FOR MASONITE AND METAL BACKING

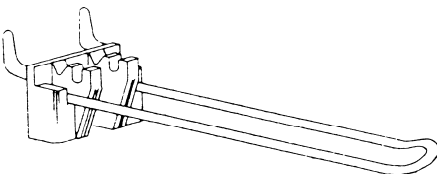

016-31-2004	4" box of 100
016-31-2006	6" box of 100
016-31-2008	8" box of 100
016-31-2012	12" box of 100

Rod = 0.148"

SCAN ADAPTOR FOR 2-PIECE DOUBLE HOOK

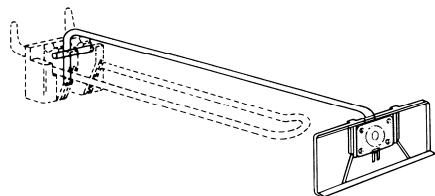

- 016-34-3004 4" box of 100
- 016-34-3006 6" box of 100
- 016-34-3008 8" box of 100
- 016-34-3012 12" box of 100

Tige seulement

PLASTIC LABEL HOLDER

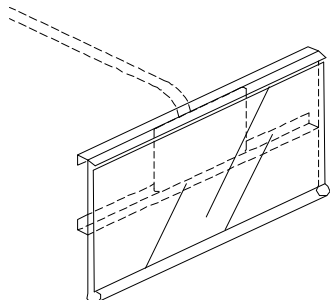

1 1/4" high x 2" long

- 016-34-2003 2" bag of 100

1 1/4" high x 3" long

- 016-34-2002 3" bag of 100

PLASTIC HOOK FOR LABEL HOLDER

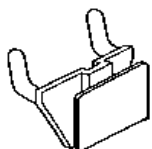

- 016-34-0000 Model WT-2 (bag of 100)

INVENTORY CONTROL CLIP



Model ICC20 & 30

- 016-13-0000 Model ICC20 **white**, bag of 250, for 4 to 8" hooks.
- 016-13-0001 Model ICC30 **black**, bag of 250, for 11 and 12" hooks.



Model ICU-2

- 016-13-0000R Model ICU-2, plastic, bag of 100

SINGLE HOOK FOR SLATWALL -CHROME FINISH

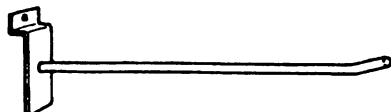

- *N070-10-0304C 4"
- *N070-10-0306C 6"
- *N070-10-0308C 8"
- *N070-10-0310C 10"
- *N070-10-0312C 12"

SINGLE SCAN HOOK FOR 1/2" x 1 1/2" CROSSBAR

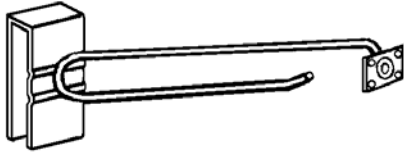

016-37-1008 8" (box of 100 pcs)

HEAVY-DUTY METAL BACK PLATE

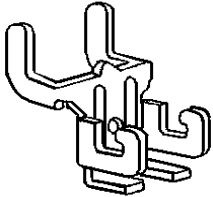

016-39-0002 Model S9000 (bag of 100 pcs)

HEAVY-DUTY PLASTIC BACK PLATE

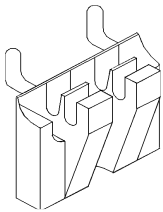

016-39-0004 Model 4000 (bag of 100 pcs)

SAMPLE PLASTIC HOOK

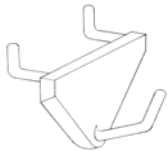

016-01-0001 White

SLATWALL ACCESSORY STEEL PLATE

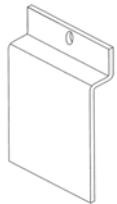

016-00-0001 1"

016-00-0000 2"

PROMOTIONAL CLIP FOR SHELF WITH LABEL MOULDING

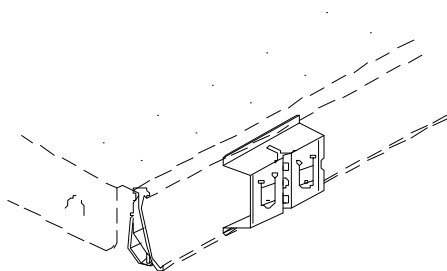

PLASTIC

011-08-0001

METAL

011-05-0003

CARD HOLDER



017-01-1108 *8½" x 11" adjustable from 12" to 24" high
zinc finish*

SIGN HOLDER

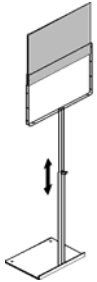

408-00-2217 *22" x 17", adjustable from 51" to 77" high*

LEAFLET PAGE DISPLAY

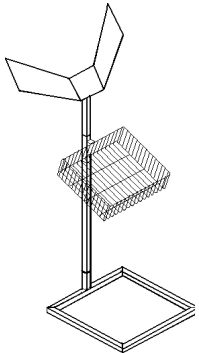

017-05-0048 *48" high with basket*

LEAFLET DISPLAY

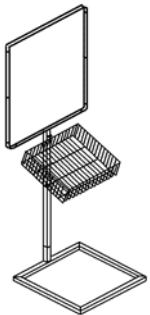

016-28-0001 *65" high with basket*

DOUBLE SIGN HOLDER ON 6" DIAMETER BASE



*Ajustable from 12" to 24" high
Ajustable from 24" to 48" high*

*with 2 6" long sign holder moulding (the signs
hang toward the bottom), black santex color.
Model 58:RSB*

PLASTIC HAND BASKET AND DISPLAY STAND



043-27-0002B *Blue basket*
043-27-0002R *Red basket*

043-27-0002J *Yellow basket*
043-27-0002V *Green basket*

043-27-0000 *12 basket capacity display stand*

Signage and orange basket not available

WIRESH MESH HAND BASKET

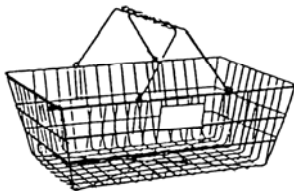

016-02-0001 *14" x 19" x 7¼" - chrome finish*

LABELING CART

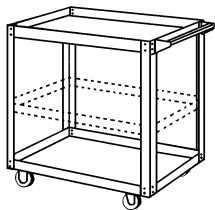

030-15-0001 *Unassembled, with 2 shelves*
030-15-0000 *Assembled, with 3 shelves*



030-15-0002 *Shelf only*

CONVEX SECURITY MIRROR (ACRYLIC)

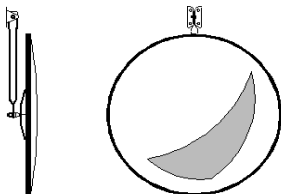

014-08-0013 *13" without arm*
014-08-0018 *18" without arm*
014-08-0027 *26"*

BUGGY WITH CASTERS TO MOVE GONDOLAS

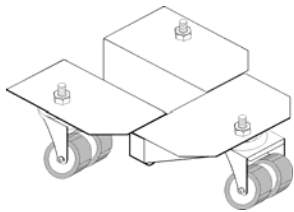

015-01-0000 *Buggy*

015-01-0001 *Pry bar to move gondolas*

CANOPY EXTENSION BRACKET

FOR 1 ELECTRICAL FIXTURE

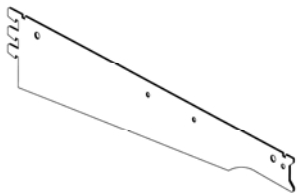

006-06-0012 *12" (adjustable from 12½" to 18½")*

006-06-0014 *14" (adjustable from 14½" to 20½")*

006-06-0016 *16" (adjustable from 18½" to 22½")*

006-06-0018 *18" (adjustable from 18½" to 24½")*

FOR 2 ELECTRICAL FIXTURES

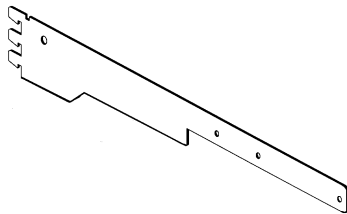

006-06-0112 *12" (adjustable from 14½" to 18½")*

006-06-0114 *14" (adjustable from 16½" to 20½")*

006-06-0116 *16" (adjustable from 18½" to 22½")*

006-06-0118 *18" (adjustable from 20½" to 24½")*

CANOPY EXTENSION

FOR 2 ELECTRICAL FIXTURES

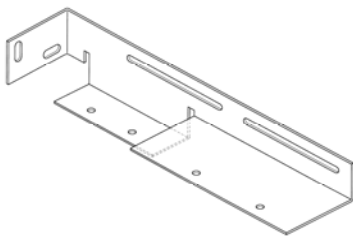

CAN-5G-0009 *Left*

CAN-5D-0009 *Right*

FOR 2 ELECTRICAL FIXTURES

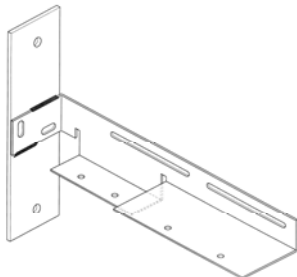

CAN-0G-0009 *10" attachment - Left*

CAN-0D-0009 *10" attachment - Right*

FLUORESCENT LIGHT FIXTURE



Neon tube not included

WITH REGULAR BALLAST - 120 V.

043-24-0001	24"
043-36-0001	36"
043-48-0001	48"

WITH ELECTRONIC BALLAST - 120 V.

043-24-0101	24"
043-36-0101	36"
043-48-0101	48"

WITH ELECTRONIC BALLAST - 347 V.

043-24-0201	24"
043-36-0201	36"
043-48-0201	48"

NEON TUBE

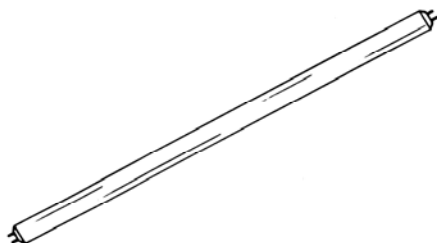

T-12

043-24-0002	24"
043-36-0002	36"
043-48-0002	48"

T-8 (DAYLIGHT)

043-24-0102	24"
043-36-0102	36"
043-48-0102	48"

5MM GLASS SHELF

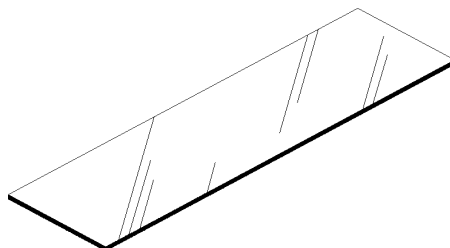

025-03-3012	12" x 30"
025-03-3610	10" x 36"
025-03-3612	12" x 36"
025-03-3614	14" x 36"
025-03-3616	16" x 36"
025-03-3618	18" x 48"
025-03-4810	10" x 48"
025-03-4812	12" x 48"
025-03-4814	14" x 48"
025-03-4816	16" x 48"
025-03-4818	18" x 48"

GLASS SHELF FRAME

H-SHAPED

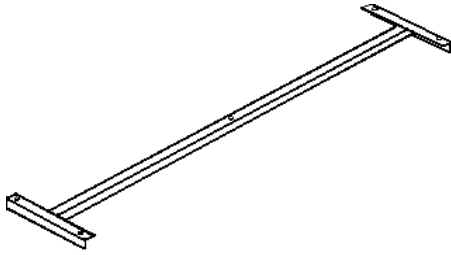

Brackets not included

025-01-2412	12" x 24"
025-01-3012	12" x 30"
025-01-3014	14" x 30"
025-01-3610	10" x 36"
025-01-3612	12" x 36"
025-01-3614	14" x 36"
025-01-3616	16" x 36"
025-01-3614	18" x 36"
025-01-4810	10" x 48"
025-01-4812	12" x 48"
025-01-4814	14" x 48"
025-01-4816	16" x 48"
025-01-4814	18" x 48"

RECTANGULAR

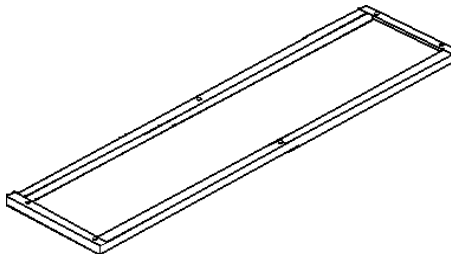

Brackets not included

025-02-2412	12" x 24"
025-02-2414	14" x 24"
025-02-3012	12" x 30"
025-02-3014	14" x 30"
025-02-3610	10" x 36"
025-02-3612	12" x 36"
025-02-3614	14" x 36"
025-02-3616	16" x 36"
025-02-3614	18" x 36"
025-02-4810	10" x 48"
025-02-4812	12" x 48"
025-02-4814	14" x 48"
025-02-4816	16" x 48"
025-02-4814	18" x 48"

INCLINABLE WITH FRONT EDGE

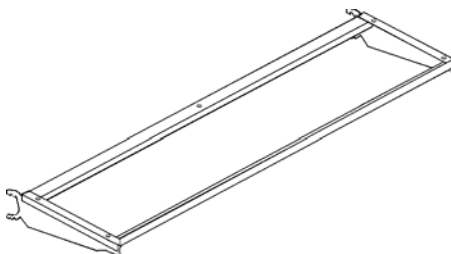

Brackets included & welded

025-04-2412	12" x 24" (with brackets)
025-04-3012	12" x 30" (with brackets)
025-04-3610	10" x 36" (with brackets)
025-04-3612	12" x 36" (with brackets)
025-04-3614	14" x 36" (with brackets)
025-04-4810	10" x 48" (with brackets)
025-04-4812	12" x 48" (with brackets)
025-04-4814	14" x 48" (with brackets)

ACRYLIC FENCE AND ATTACHMENT

ACRYLIC FENCE

1/4" THICK X 4" HIGH (3" EXPOSED)

043-28-2404	23½"
043-28-3004	29½"
043-28-3604	35½"
043-28-4804	47½"

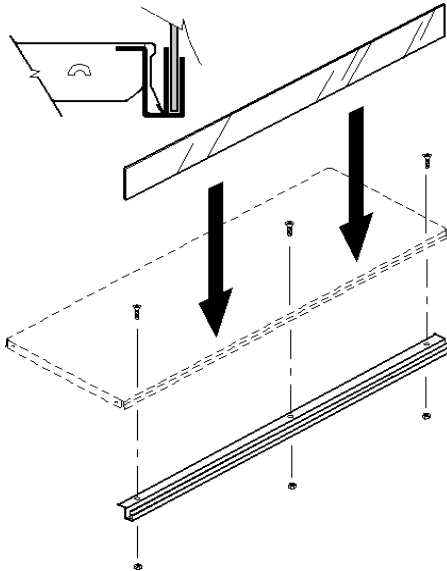

1/4" THICK X 6" HIGH (5" EXPOSED)

043-28-2406	23½"
043-28-3006	29½"
043-28-3606	35½"
043-28-4806	47½"

ATTACHMENT FOR ACRYLIC FENCE

FOR SHELF WITHOUT LABEL MOULDING

043-28-0024	24"
043-28-0030	30"
043-28-0036	36"
043-28-0048	48"

FOR SHELF WITH LABEL MOULDING

043-28-0024A	24"
043-28-0030A	30"
043-28-0036A	36"
043-28-0048A	48"

ADAPTOR FOR UNIVERSAL SYSTEM

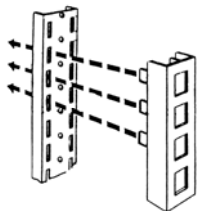

011-03-0004	4½"
-------------	-----

KICKPLATE DRAWER ON CASTERS

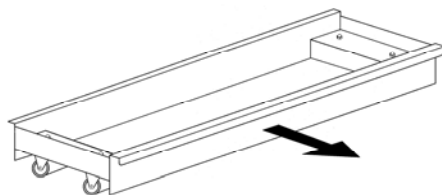

TIR-01-3612	12" x 36"
TIR-01-3616	16" x 36"
TIR-01-4812	12" x 48"
TIR-01-4816	16" x 48"

BAG HOOK

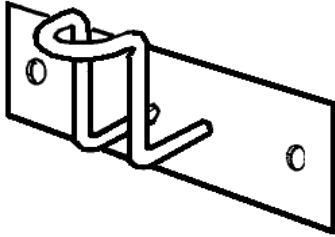

043-16-0002 1" x 4"

HAND BAG HOLDER (2 PARTS)

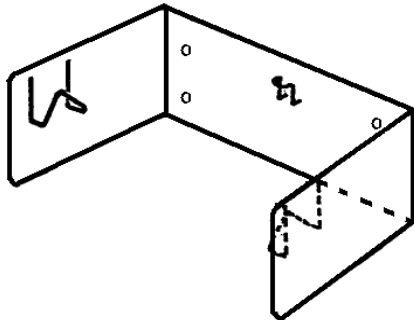

425-01-0002 *Hand bag holder, includes the upper and lower parts. 8" x 12" x 4"*

Hand bag holder, includes the upper and lower parts. 8" x 12" x 4"

Upper part

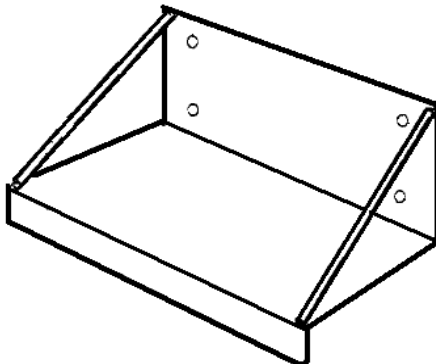

Lower part